

Caregiving Bathing Device SWB-1000CN

User Manual

Please read this manual thoroughly before use.

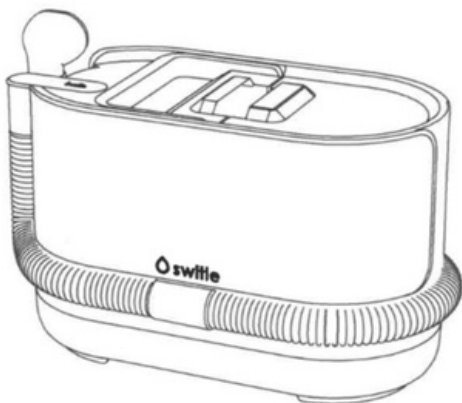

Please confirm before use ...	1
Safety precautions ...	2
Parts names ...	4
Preparation ...	5
Usage ...	8
Maintenance ...	10
Troubleshooting ...	11
Specifications ...	12
Warranty Terms ...	13
After-sales Service ...	13
Warranty Card ...	15

Thank you very much for purchasing switle BODY.

To ensure proper use, please read this user manual carefully before use.

Please keep this manual in a place where it can be easily accessed by the user even after reading.

switle BODY is

One caregiver alone can comfortably and safely attend to the care recipient while they remain in their regular bed, without wetting or soiling it, making it convenient, easy, and comfortable. Using specialized mildly acidic soap for a refreshing cleanliness! Using it feels just like taking a shower, ensuring a thorough bathing experience.

As of October 30, 2023, according to a survey conducted by Stella Associates Co.,Ltd., portable showers that provide hot water and soap.

Effective in various care scenarios.

On November 5, 2024, the Switle BODY bathing machine won the **Japan GOOD DESIGN AWARD Gold Medal.**

Features

1. Drip-free Wet Suction Attachment

It sprays water and suctions while washing, allowing you to bathe without wetting the bed.

2. Automatic Water and Special Soap Spray System

The water temperature can be adjusted between 38°C to 45°C according to your preference.

Approximately 1 liter of water is sufficient for pre-washing, bathing, and rinsing※1. Additionally, a small amount of soap (about 10-30cc) is enough to wash the entire body※1.

3. All-in-One Design with Built-in Clean Water, Waste Water, and Soap Tanks

Lightweight design at 5.5kg※2 easy to carry for a wide range of users.

Simply fill with water and special soap, plug into an outlet, and it 's ready to use.

Easy to use with just one caregiver.

※1 :May vary depending on body size and shape. Some areas, such as between fingers, may not be fully cleaned.



※2 :Excluding the weight of water and soap.

Please Confirm Before Use

1. switle BODY is a bathing device. It cannot be used for purposes other than bathing
2. Do not use the silicone head on ears, eyes, nose, or mouth.
3. Do not use if there are wounds, swelling, or other skin conditions.
4. For individuals with severe symptoms, please use under the guidance of a doctor.
5. For those with skin diseases or infections, please follow the doctor 's instructions.
6. This product does not have a disinfection function. Please maintain hygiene by cleaning it regularly. The company assumes no responsibility for bacterial infections or the transmission of pathogens.

Safety Precautions

Please read these safety precautions carefully before use to ensure proper usage. The precautions listed here are to prevent harm or damage to the user and others. The level of harm or damage that may occur due to improper use is categorized as follows.

 Warning	Indicates a potential risk of death or serious injury if mishandled.
 Caution	Indicates a potential risk of minor injury or material damage if mishandled.

■ The types of precautions are categorized and explained using the following symbols.

	 Symbol indicates prohibited actions (e.g., disassembly or repair is prohibited)	 Symbol indicates mandatory actions (e.g., unplug the power cord)
---	---	--

After reading, please keep this manual in a place where it can be easily accessed by the user.

Warning

Power Plug, Cord, and Outlet



Dust on the power plug should be wiped off with a dry cloth.

Must be

Accumulated dust can cause a fire.

Ensure the power plug is fully inserted into the outlet.

Loose connections can cause electric shock, short circuits, or fire.

When unplugging, always hold the plug, not the cord, to avoid electric shock, short circuits, or fire.

Loose connections can cause electric shock, short circuits, or fire.



Unplug

Always unplug the power cord before cleaning. Do not plug or unplug with wet hands.

Causes of electric shock or injury.

Must unplug the power when not in use for a long time.

Deterioration of insulation can cause electric shock or fire due to electrical leakage.



Prohibited

Do not use if the cord or plug is damaged.

Loose connections can cause electric shock, short circuits, or fire.



Do not damage the wires or process them or bear excessive loads.

Damaged wires may cause fire or electric shock.

Main Unit



Prohibited

- Do not spray insecticides, hairspray, lubricants, etc., on the unit.
- Do not use near flammable substances like kerosene, gasoline, or thinner.
- Do not use in areas with oil fumes or smoke.

Possible causes of fire.



Prohibited

Do not pour water over the main unit. The unit cannot be washed.

Possible causes of malfunction.

※Please refer to page 10 for maintenance information.



Must be

If the unit is stored below 0°C and not used for a long time, drain all liquid from the bathing liquid tank, clean water tank, wastewater tank, and hoses to prevent freezing and ensure normal operation so that no water remains that could freeze and affect the normal use of the hoses, bathing liquid tank, clean water tank, or wastewater tank.

Warning



Must be

Be sure to confirm the water temperature before using hot water mode. Please refer to page 8 for usage instructions.

Depending on the room temperature or water temperature of the usage environment or the season, the actual water temperature may be higher or lower than the set temperature. Please be sure to test the water temperature with your hands before use.



Must be

Maintenance must be performed after use. See page 10 for maintenance instructions.

Failure to perform maintenance may result in the growth of mold, bacteria or odor.



Must be

When an abnormality or malfunction occurs, please stop using it immediately, turn off the power and unplug it.

May cause smoke, fire, electric leakage, or injury.

- Can't start when pressing power.
- Abnormal noise occurs during use.
- Even when plugged in, the device intermittently fails to start.
- Plug or cord is unusually hot.
- Sudden stop during use.
- Other abnormalities or failures.

Unplug the power immediately and contact your retailer or distributor.



Prohibited

Not to be disassembled or repaired or modified by yourself.

May cause fire, electric shock, or injury.

No repairs may be attempted except by technicians.

Caution



Must be

Use only the specified soap. For details, please refer to page 7.

May cause malfunction.



Must be

When multiple people use the same shower head, be sure to wash the shower head with medical disinfectant before use.



Must be

Must be placed in a level and stable place for use. Otherwise, the device may fall or flip over, causing damage or injury to the user.



Prohibited

Do not use when the shower head is not installed.

May cause water to spurt out.



Prohibited

Do not hit or drop the device.

May cause malfunction or damage.



Prohibited

Do not pull or excessively twist the hose when using it.

May cause malfunction or damage.



Prohibited

No other items may be placed on the device. May cause malfunction or damage.



Must be

Stop use immediately if foreign objects are inhaled. Remove them before resuming.

May cause malfunction or damage.



Unplug

If not used for a long time, please unplug the power.

May cause fire or electric leakage.



Prohibited

Do not attract dust.

May cause malfunction or damage.

Parts Names

■ Main Unit

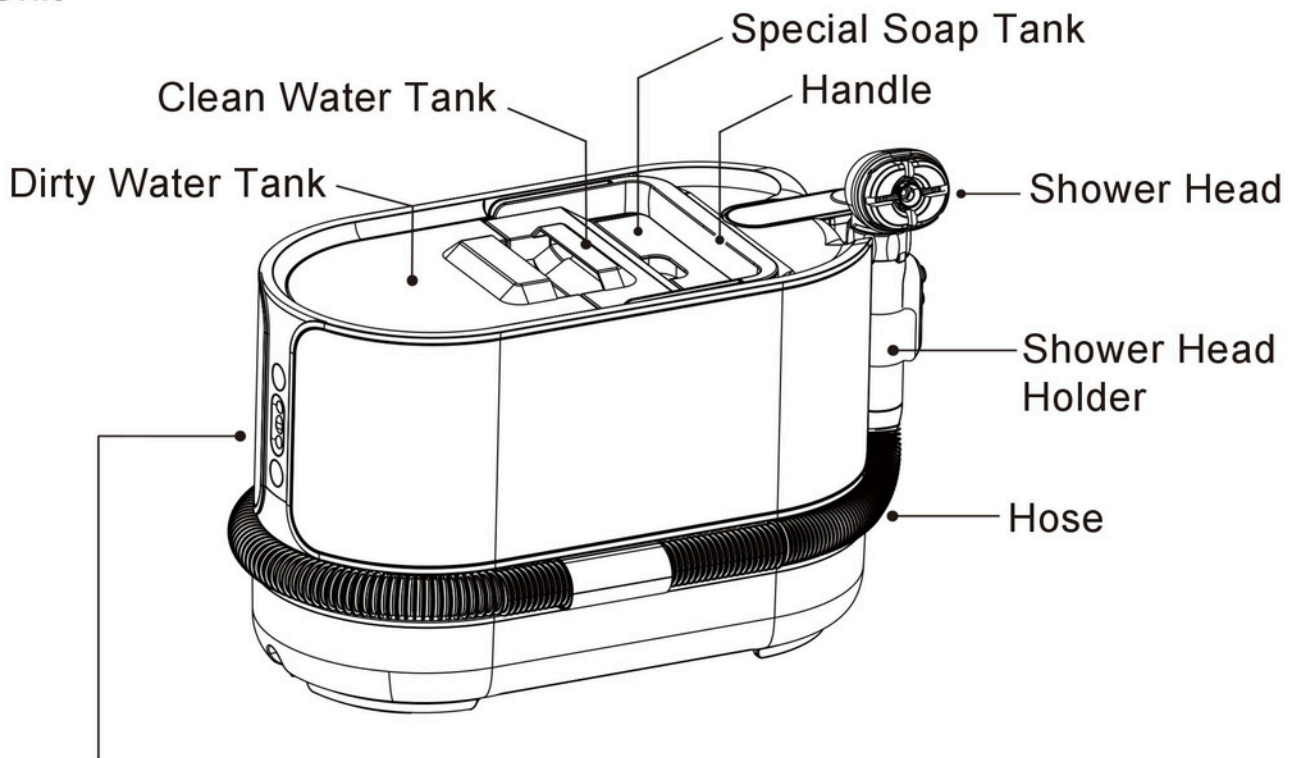

■ Control Panel

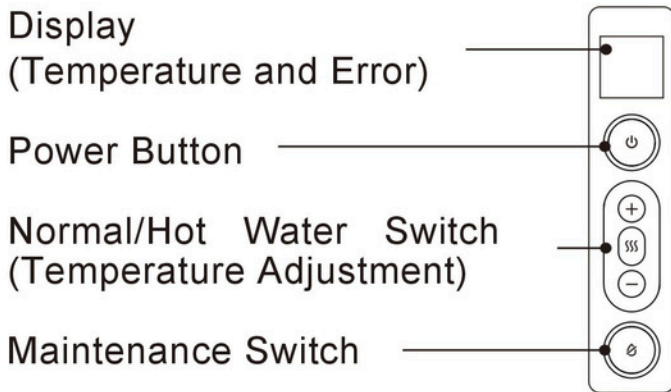

For details, please refer to P.5.

■ Shower Head Set

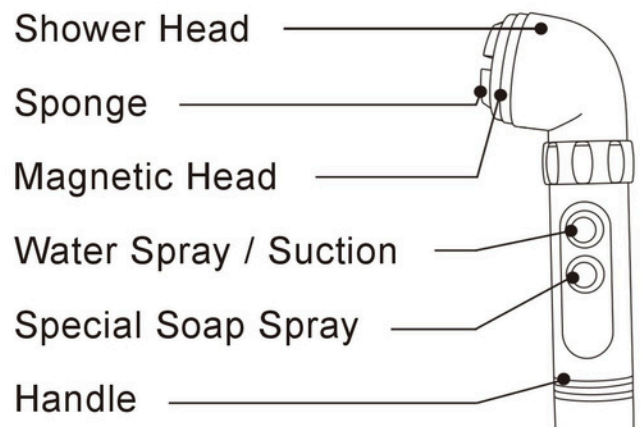

■ Bottom Side

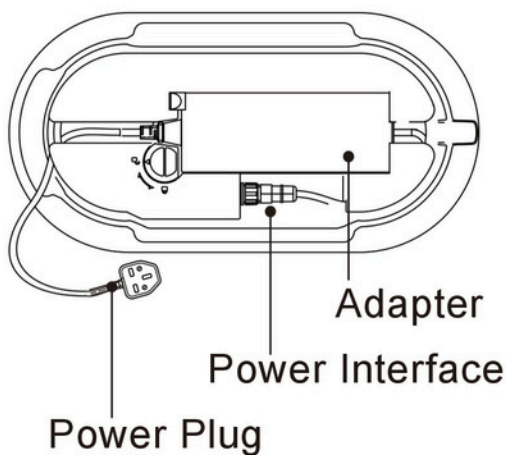

In addition to the sponge head, we also have a silicone head specifically for hair.

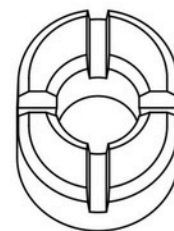



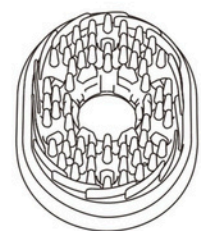

Sponge
(Bod Wahsing)





Silicone Head
(Hair Washing)

Parts Names (Continued)

Control Panel

 Power ON / OFF	Turns the power ON and OFF.
 Temperature Adjustment (Increase)	In hot water mode, pressing the button increases the water temperature by 1°C each time. The maximum temperature is 45°C.
 Normal Temperature / Hot Water Mode Toggle	Each press of the button switches between normal temperature mode and hot water mode. When the power is turned on, it starts in normal temperature mode. When switched to hot water mode, the default setting is 42°C.
 Temperature Adjustment (Decrease)	In hot water mode, pressing the button decreases the water temperature by 1°C each time. The minimum temperature is 38°C.
 Maintenance Switch	Turns the suction mode ON and OFF. ※When the dedicated soap spray button is pressed, the suction function temporarily stops.

Shower Head Set

 Water Spray / Suction	When the button is pressed, water (hot water) is sprayed for the first 2 seconds, then water is sprayed while being simultaneously suctioned. When the button is released, the water spray stops, and suction stops 5 seconds later.
 Special Soap Spray	When the button is pressed, special soap is dispensed. When the button is released, special soap stops dispensing.

⚠ Caution The set water temperature may vary depending on the temperature of the water put into the clean water tank.

Preparation

Main Unit and Adapter

1. Turn the main unit over and take out the cord.
2. To remove the adapter to extend the cord, turn switch ① to the unlocked position and lift switch ② to remove the adapter. To reattach, follow the steps in reverse.

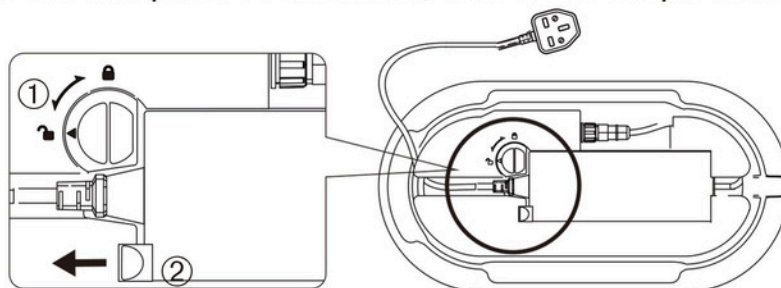

※: If the adapter reaches 75°C or higher, the safety device will activate and the adapter will stop working. If you plan to use the adapter repeatedly, please remove it from the main unit before use.

Preparation (Continued)

■ Shower Head Set

1. Turn the ring at the end of the hose clockwise.

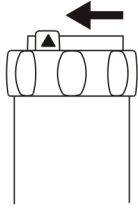

2. Insert the shower head into the handle, aligning the arrow with the unlock mark [■].

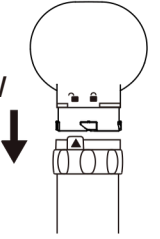

3. Turn the ring counterclockwise to the lock position [■] to secure it.

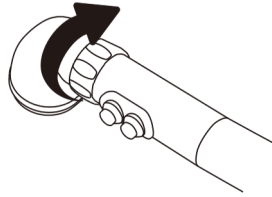

<Remove the shower head>
Turn the ring clockwise until the arrow is aligned with the unlock mark [■], then pull out the head.

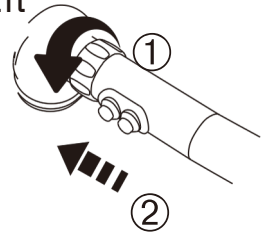

■ Attaching the Sponge or Silicone Head to the Shower Head

- Use the sponge for bathing and the silicone head for hair washing.
- Attach the sponge by securing it with the magnetic head.

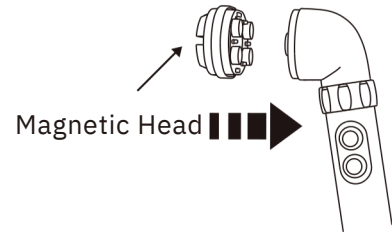

<Attaching the Sponge / Silicone Head>

1. From the backside of the magnetic head, pinch the fastener and remove the sponge retainer.

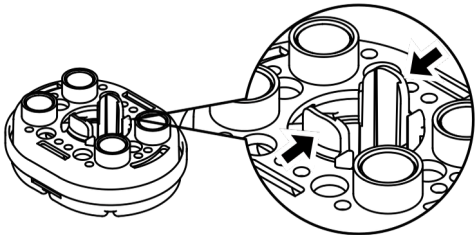

2. Attach the sponge to the magnetic head and install the sponge retainer.

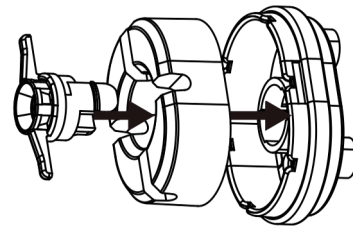

3. When using the silicone head, align the hooks of the silicone head with the grooves of the magnetic head and attach it.

4. Align the magnetic head with the shower head and securely fix it using the magnet.

※Note: In this case, the sponge retainer is not used.

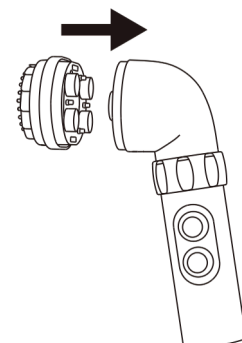
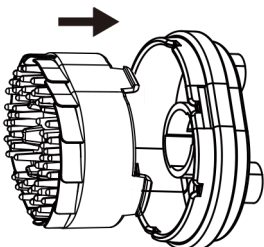

Preparation (Continued)

■ Filling the Clean Water Tank / Preparing the Special Soap

1. Remove the clean water tank, open the cap, and fill it with tap water.
2. Remove the fresh water tank, lift it up, take out the special soap tank, open the cap and add the special soap.

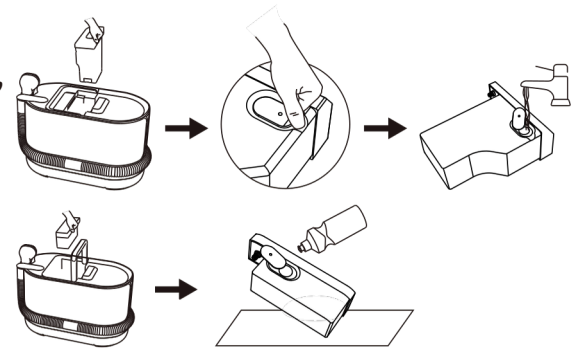

Note:

※Only use switle BODY special soap.

Using other soaps may cause malfunctions and void the warranty.

switle BODY special soap (900ml)

- It is non-foaming and easy to clean, and can be used to wash your hair and body at the same time.
- It is gentle, non-irritating and can wash away dirt from the human body.
- The same weak acidity as skin.
- Please confirm the instructions on the packaging before use, including usage instructions and precautions.
- Only use switle BODY special soap. Using other soaps may cause malfunction.



■ Confirmation

1. Ensure the shower head is properly connected to the hose.
2. Use only the official shower head.
3. Plug in the power cord and turn on the power switch to confirm normal operation.
4. Check that the sponge or silicone head is clean before use.
If it is dirty, please wash it before use.
5. Check for any deterioration or damage to the sponge, silicone head, or hose.
6. Ensure there are no unusual noises from the main unit.
Make sure the sponge and silicone head are installed correctly.
7. Prepare the necessary items for taking a shower.
8. Such as towels or hair dryers or wash basins, etc.
9. Confirm that there is no residual sewage in the waste water tank.
10. If there is sewage, please pour it out first and wash it.
11. Make sure there is sufficient water and special soap.

Usage

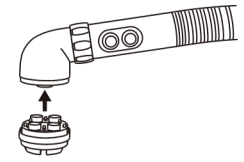
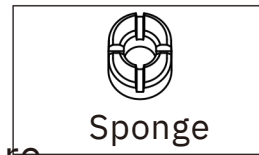

■ Body Washing

1. Attach the sponge to the magnet head.
2. Turn on the power and adjust the temperature.



<Switch between Normal Temperature / Hot Water Mode>

※It automatically enters normal temperature mode after turning on.

- Press the  button to switch between normal temperature / hot water mode.
- Press the  button to adjust the temperature.

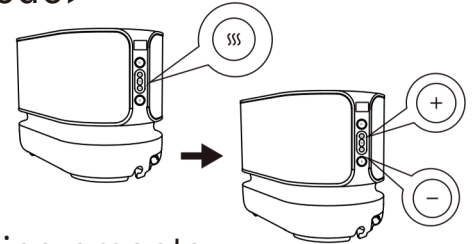

Adjust the temperature between 38°C to 45°C in 1°C increments.

After the temperature adjustment is completed, please actually discharge water to confirm.

The temperature on the display will start flashing after the water starts to flow out.

It stops flashing after heating reaches the set temperature.

Warning

When using in hot water mode, be sure to confirm the temperature with your own hands first. Without checking the temperature, it may cause burns.

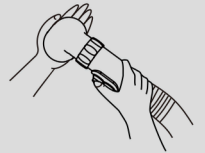

3. Place a bath towel around the bed if using on a bed or futon.
4. Press the water spray / suction button while keeping the sponge in contact with the skin. Suction will continue for 5 seconds after releasing the button.

<Correct usage>

Keep shower head flush against skin.

Without releasing,
keep pressing the button.

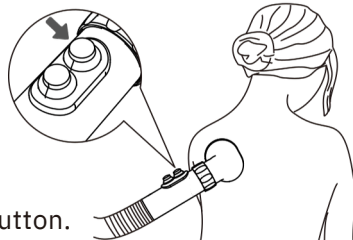

<Wrong usage>

If shower head is not in contact with the skin, water leakage will occur.

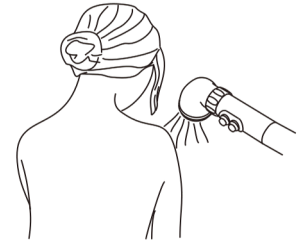

5. Press the special soap spray button to apply soap, then use the sponge to wash.

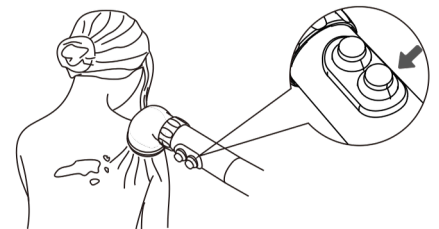

When the fresh water tank is empty, the display will show "水補充"(Refill water) When the soap tank is empty, the display will show "ソープ補充"(Refill soap). When these messages appear, refill with water or soap.

補充
沐浴露

補充
清水

6. Press the water spray/suction button again to rinse.
Press the maintenance switch on the main unit to remove any remaining water droplets.
Also, wipe with a towel if necessary. 8

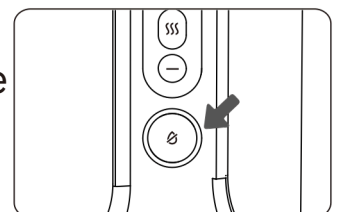

Usage (Continued)

7. After bathing, empty the dirty water tank.

If the dirty water tank is not emptied and used continuously, once there is more than 2 liters of sewage, the sewage will flow back into the motor, possibly causing malfunction.



Caution

- Make sure to press the water spray / suction button after placing the sponge on the skin.
- Make sure to keep the sponge in contact with the skin when washing. If it comes off, water may leak out.
- Even if you release the water spray / suction button, suction will continue 5 seconds. Once suction has finished, remove the sponge from the skin. We recommend wiping areas between fingers, under arms, and around groin with a towel.
- Because sponges have a high water retention capacity, if you plan to use the sponge again while it is still wet, please remove any excess water with paper or a towel before using it again.
- When using and after use, please hang the shower head on the shower head holder. If you place the shower head on a bed, futon, or floor, water may flow out from the hose.
- Once washing is complete, be sure to empty the dirty water tank.

Hair Washing

1. Attach the silicone head to the magnet head.



2. Press the water spray/suction button while keeping the silicone head in contact with the hair.

Even if you release the water spray / suction button, suction will continue 5 seconds.

3. Move the silicone head from top to bottom like combing.

If you use it to wash your hair from different directions, it will cause the hair to become tangled or fall out.

4. When the hair is all wet, spray an appropriate amount of special soap.

5. Move the silicone head from top to bottom like a comb and let the special soap clean your scalp and hair. Let the special soap clean scalp and hair.

6. Rinse by pressing the water spray / suction button again.

7. After rinsing the soap away, if there is still any moisture left in your hair, wipe it with a towel.

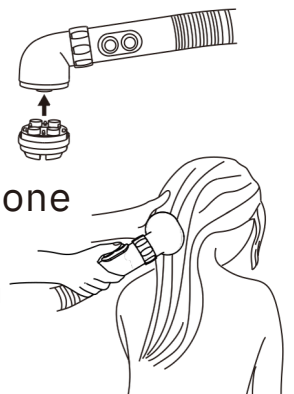

Maintenance

- Before performing any maintenance, make sure the power is turned off and the power plug is unplugged from the outlet.
- Be sure to clean after use.
- If the product is very dirty, wipe it with a cloth soaked in a diluted neutral detergent. Finish by wiping with water and then wiping with a dry cloth. Cleaning with a brush or other hard material may cause scratches. Also, do not wash the product by pouring water directly on it. This may cause a malfunction.

Hose care

Please perform maintenance on the hose after each use:

1. Add about 1 liter of low-concentration hypochlorous acid solution (prepared by yourself) to an empty container, immerse the shower head section in the solution, then switch to suction-only mode to draw the solution into the wastewater tank.
2. After emptying the wastewater tank, add 1 liter of clean water to the container and switch to suction-only mode again to rinse out the hypochlorous acid solution.



Piping maintenance

The internal piping of the bathing assist unit needs regular maintenance to prevent limescale buildup.

1. Use a commercially available citric acid descaling agent.
2. Fully dissolve the descaling agent in clean water (the water temperature must not exceed 50°C, otherwise the clean water tank may be damaged).
3. Pour the solution into the clean water tank.
4. Turn on the unit, switch to heating mode, and hold the spray button for 5 minutes (you may extend the time for better results).
5. Empty the descaling solution from the clean water tank to complete the maintenance.

Notes:

- ※ Perform piping maintenance once a week to effectively prevent limescale buildup.
- ※ If the bathing assist unit has not been used for a long time, perform piping maintenance before using it again.

⚠ Caution Do not immerse the handle in water. May cause it to break down.

Care for sponge / silicone head

- After washing by kneading with hypochlorous acid solution or antibacterial hand soap, rinse thoroughly with clean water.
- Place it in a UV sterilization box for ultraviolet sterilizing and drying (temperature below 70°C).
- If you wish to reuse a dried sponge, rinse it under water while gently kneading it until it becomes completely soft. Using it forcibly while dry and hard may cause skin discomfort and damage the sponge.

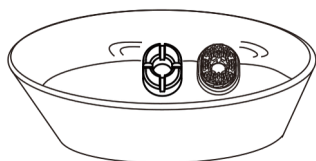

Immerse in disinfectant water

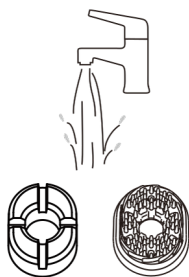

Rinse off disinfectant water

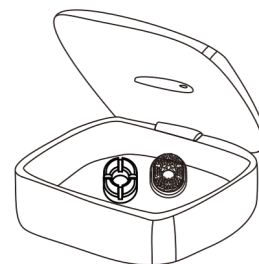

Put it in a sterilized box

Maintenance (Continued)

■ Dirty Water tank care

1. Take out the dirty water tank and turn the lid clockwise to open it.

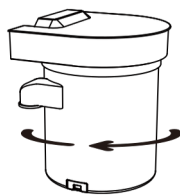

2. Discard the dirty water from the dirty water tank, clean it, and finally rinse it with clean water.

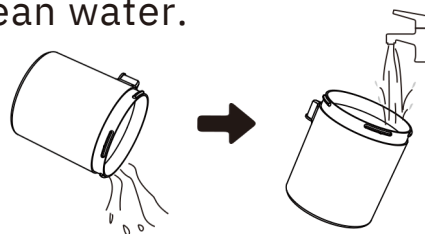

3. Allow to dry completely, then attach the lid and adjust it so that the ▼ mark aligns with the unlock mark [🔓] at the bottom.

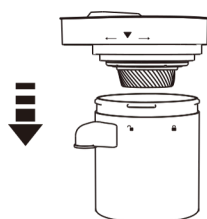

4. Turn the lid counterclockwise so that the ▼ mark on the lid is at the lock mark [🔒] at the bottom, and check that it is completely sealed.

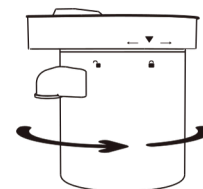

⚠ Caution • After cleaning, dry thoroughly before installing.
 • If you will not be using the product for a long period of time, unplug the power cord from the outlet. Deterioration of insulation can cause electric shock or fire due to electrical leakage.

If you think there is a problem

Error notification (displayed digitally)

Display	Cause	Treatment
Water and soap refilled but display show "水補充" or "ソープ補充"	The fresh water tank or dedicated soap tank installed in the correct place or is not fully inserted.	Please install the clean water tank and the special soap tank in the correct position.
	Foreign matter is stuck.	Remove any foreign objects from the suction port. If the message persists even after removing the foreign object, please contact us.
E0	Hose is not attached correctly.	Stop operation and contact the store where you purchased the product.
E1	The circuit board inside the device is hot.	Stop operation and allow the device to cool down. Please resume operation after a certain period of time has elapsed.
E2	water temperature is high.	You cannot fill the tank with hot water. If the display does not change even after filling it with water, please ask the store where you purchased the product.
E3	AC adapter is hot.	Stop operation and allow the AC adapter to cool before restarting operation.

If you think there is a problem (Continued)

Before requesting repairs, please carry out the following checks. If you still find an abnormality, discontinue use to prevent accidents and contact the store where you purchased the product.

⚠ Please do not disassemble, repair or modify the product yourself as it is dangerous.

Situation	Cause	Treatment
Water doesn't come out	Power is off	Please turn on the power
	There is something stuck in the hose	Please remove any foreign objects
	There is no water in the clane water tank	Add water to the clane water tank
	In suction mode	Please cancel suction mode
No special soap available	Special soap tank is not installed or not installed properly	Please install the special soap tank correctly
	There is no soap in the soap tank	Please refill the special soap
Water leaks	Shower head properly not installed	Check the shower head
	There is something stuck in the suction port	Please remove any foreign objects
	The tank cap is not properly attached	Check the tank
	The main body is tilted	Please install it on a horizontal place
Do not suction	The rubber ring on the back of the waste water tank lid has come off	Please install the rubber ring correctly
Strange smell	The dirty water tank and hose are dirty	Please clean each part

Specification

Product name	Careeiving Bathing Device switle BODY
Product number	SWB-1000CN
Body size	Width 480mm x Length 230mm x Height 290mm
Weight	5.5kg (excluding water)
Hose length	1.25m (from the base of the body to the tip of the head)
Power cord length	2.2m
Tank capacity	Clane water tank: 1.8L / Dirty water tank: 2.0L / Special soap tank: 300ml
Mode	Normal temperature / Hot water / Suction
Water temperature range	38~45°C

After-sales Service and Warranty

Warranty Description

- This instruction manual includes a warranty card.
- Please fill in the purchase date, purchase channel, and other details on the warranty card and keep it safe.
- The warranty period is one year from the date of purchase. Within one year, products with quality issues will only be replaced and not repaired (this does not include issues caused by human operation).

After-sales Service Process

In case of failure, please troubleshoot according to the previous "Troubleshooting" section:

- **Within the warranty period:** Repairs will be carried out by the factory based on the contents filled in the warranty card provided with the product.
- Even within the warranty period, if the failure is caused by incorrect user operation, maintenance fees will be charged.
- **Beyond the warranty period:** If the product's function can be maintained through repair, maintenance fees will be charged according to the customer's request.

Composition of Maintenance Costs

Cost Item	Description
Shipping	Shipping costs are borne by the after-sales service provider.
Technical Fee	Includes diagnosis, repair, adjustment, and inspection fees.
Parts Fee	Costs for the parts and auxiliary materials used for repair.

After-Sales Service Customer Contact

Please first consult the channel or dealer where you purchased the product.

If you cannot contact them, please contact the following customer service:

Phone Support

Service Hours: Monday to Friday
(excluding statutory holidays) 10:00–18:00.
Whatsapp: [852-9150 0616](https://www.whatsapp.com/channel/002991500616).

Customer Personal Information Handling

When providing after-sales service, we will properly manage collected customer information such as names, addresses, and phone numbers.

Except with the customer's consent, or as required by law for business entrustment or contact, this information will not be disclosed to third parties. Additionally, calls may be recorded to ensure accurate handling of requests.

Warranty & Claims

Warranty Period

The switle BODY® is covered by a **12-month limited** warranty. This period begins on the **11th day after delivery**.

Coverage

Defects in materials or workmanship affecting normal operation.

Failures of key components as listed in the product specifications (e.g., motor, heating element, water tank).

How to Claim a Warranty Repair

1. **Contact Support:** Notify BNFT-TECH Customer Service within 30 days of discovering the defect.
2. **Prepare Info:** Please have your product's Serial Number, proof of purchase, a description of the fault, and photos if possible ready.
3. **Inspection:** BNFT-TECH will arrange for an authorized service technician to perform an inspection.
4. **Resolution:** If the defect is covered under warranty, the product will be repaired or replaced free of charge.

Non-Warranty Repairs (User Negligence)

Please note: If an inspection reveals that the defect was caused by user negligence, misuse, or accidental damage, the cost of parts and labor will be charged to the owner.

Consumables & Warranty Protection

Only use the dedicated body wash (switle BODY® body wash specially designed for Switle BODY®, 900 ml).

Important: Using other soaps, detergents, or cleaning agents may damage internal components and **will void the warranty**.

Water Quality Recommendation

Use clean tap water.

Note: Avoid water with high mineral content (hard water), as this causes scaling and reduces performance.

Service & Repair

Authorized Service Only

All repairs must be performed by a technician authorized by BNET-TECH.

- Internal components (motor, heating element, PCB) must only be replaced by BNET-TECH professionals.

No Unauthorized Modifications

1. Do not disassemble, modify, or attempt to repair the device yourself.
2. Opening the main unit or modifying internal parts voids the warranty and may result in injury or electric shock.

Service Procedure

3. Turn off the power and unplug the unit.
4. Perform the cleaning steps outlined in the “Maintenance” section (Page 7).
5. If the fault persists, contact BNET-TECH support to schedule service.

Safety Precautions

- Do not submerge the unit in water or any liquid.
- Keep the device away from children and pets during operation.
- If the display shows an error code (E0–E3), stop operation immediately and contact BNET-TECH support.

Important Liability Notice

Proper Use

- BNET-TECH cannot be held liable for injury, damage, or product failure resulting from misuse, negligence, or failure to follow the instructions in this manual.
- The user is responsible for ensuring the device is operated strictly in accordance with these safety warnings.

Warranty Card

Product Name	Switle BODY Smart Temp Control Portable Bathing Machine	Model	SWB-1000CN
Warranty Period	Within one year from date of purchase	Purchase Date	Year ____ Month ____ Day ____
Consumer	Name: Address:	Phone no.:	
Channel / Dealer	Sales Unit: Address:	Phone no.:	

Warranty Card Precautions:

1. This warranty card is invalid if the contents are not filled in; please ensure all information is accurate.
2. switle BODY® provides a 12-month limited warranty. The warranty period begins on the 11th day after the product is received.
3. **During the warranty period, paid repairs will be required under the following circumstances:**
 - ① Faults or damage caused by incorrect use, modification, or improper operation.
 - ② Faults or damage caused by dropping or transportation after purchase.
 - ③ Faults or damage caused by fire, earthquake, flood, lightning, or other natural disasters, abnormal voltage, or other external factors.
 - ④ Faults or damage caused by harsh environments, excessive use, or installation for special purposes such as on vehicles or ships.
 - ⑤ Lack of a warranty card, failure to fill in the purchase date, customer name, or purchase channel, or if the information is found to have been altered.
 - ⑥ Faults, damage, deformation, or discoloration caused by the use of non-proprietary body wash.
4. **If you cannot apply for maintenance through the purchase channel or sales point, please consult our company's after-sales service.**
5. **This warranty card is restricted for use in Hong Kong, China.**
6. **This warranty card will not be reissued; please keep it safe to avoid loss.**



Online warranty registration

※ Remarks:

This warranty card promises free repairs within the above warranty period and conditions. For any unclear maintenance situations exceeding the warranty period, please consult the purchase channel, dealer, or our after-sales service personnel. The after-sales and maintenance terms mentioned in this manual apply only to products sold through retail channels.

Certificate of Conformity

The product has passed inspection and is approved for factory release.